



VDOT-ASD-400

**Aspirating Smoke Detector
User's Manual**

Content

Introduction	3
Features	3
Specification	5
Sampling Pipework Design	8
Considerations	8
Design Guidelines	11
Installation	13
Mechanical Installation	13
Electrical Installation	15
Front Panel	20
Control	21
Display	21
Parameter Setup	25
Parameter Functions	27
Commissioning	32
Commissioning Check List	32
Maintenance	34
Appendix	38
Pipe Scan	38
Zone Relay Board	41

Introduction

VDOT-ASD-400 is aspirating smoke detectors especially developed by ASD prevent CO., Ltd. for large open space very early warning fire detection.

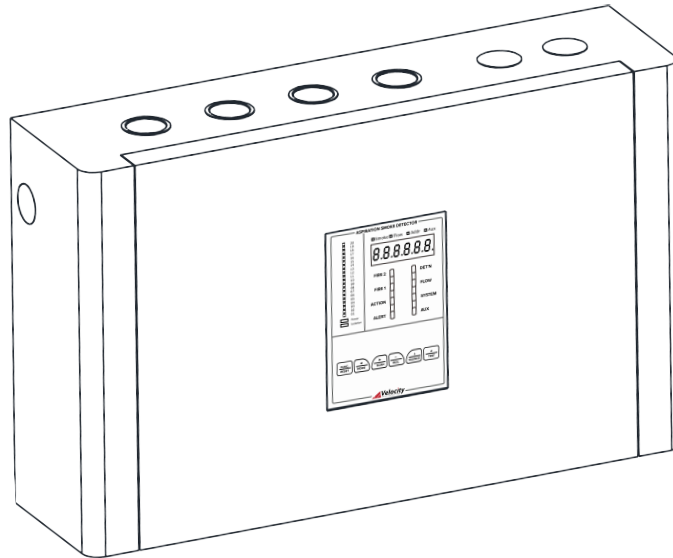

Due to the nature of aspirating smoke detection systems, the air samples from all the individual sampling pipes are drawn into one central detection unit causing the smoke particles to mix, making the identification area difficult to determine. However, one of the advantages of VDOT-ASD-400 is that it has four independent aspirators; each aspirator is connected to its own pipe inlet. Therefore, it can easily identify the smoke origin simply by the control of each aspirator on and off to see which pipe has the highest smoke level. This ASD patented pipe scan process identifies the pipe that contains the most smoke, extremely useful when using the four-pipe aspirating smoke detector. This multi-pipe system is designed to protect large areas, the pipe scan system can quickly and automatically identify the individual pipe, reducing the search area down drastically to a quarter of the protected area, making the fire search much easier. Features

Features

ASD uses high power, short wavelength blue LED as the detection light source. It is very sensitivity to small smoke particles generated during the incipient stage of a fire, at which time remaining invisible to human eyes. The highest alarm sensitivity of ASD high sensitivity smoke detector is 0.005%/m, which is 1000 times more sensitive than a conventional point type smoke detector.

- Alarm Sensitivity Range: 0.005~20%/m
- Four Alarm Levels
- Automatic and Manual Pipe Scan

- Up to 4x100m Pipe Length* (4x10 sampling holes)
- Up to 4x25 Sampling Holes* (4x60m sampling pipe length)
- 7 Relays Outputs on Termination Board
- 16 Relays on Zone Relay Board (Optional)
- 3 in 1 Control/Display/Programmer Front Panel
- RS485 Network
- Support Modbus RTU Open Protocol

**Note: Maximum pipe length and maximum number of sampling holes cannot be achieved at the same time. When maximum pipe length is the major design consideration, the number of sampling holes must be reduced. On the other hand, when maximum number of sampling holes is the major design consideration, the pipe length must be reduced.*

Specification

Smoke Detection Principle

- Forward Light Scattering Mass Detection
- High Power Blue LED

Smoke Sensitivity

- Smoke Detection Range: 0.001~25%/m
- Alarm Sensitivity Range: 0.005~20%/m

Important Note:

Operation of the Detector beyond 12%/m obscuration is not allowed per the National Fire Alarm Code (NFPA 72) guidelines.

Sampling Pipe

- Material: ABS/UPVC
- OD: 25mm

Maximum Pipe Length and Sampling Holes

- EN54-20 Class A: Maximum 40 holes totally
 - 4x100m (4x10 holes)
 - 3x100m (3x13 holes)
 - 2x100m (2x20 holes)
- EN54-20 Class B: Maximum 60 holes totally
 - 4x100m (4x15 holes)
 - 3x80m (3x20 holes)
 - 2x60m (2x25 holes)
- EN54-20 Class C: Maximum 100 holes totally
 - 4x60m (4x25 holes)

**Note :*

Please refer to Velocity ASD Design manual for the relationship between pipe length and the number of sampling holes.

The ASDFlow air sampling pipe network design tool can be used to calculate the maximum transport time and sampling hole sensitivity.

Alarm Levels and Time Delay

- Alert (0~60 sec.)
- Action (0~60 sec.)
- Fire-1 (0~60 sec.)
- Fire-2 (0~60 sec.)

Environment Smoke Learning

- 24hours, 365days Non-Stop Smoke Background Level Learning

Flow Detection

- Detection Principle: Heat Mass Detection
- Pipe Flow Normalize to 100%
- Flow High and Flow Low Fault
- Adjustable Flow Detection Sensitivity
- Adjustable Flow Fault Threshold

Relay Output

- 7 Relays on Termination Board (Configurable)
- Rating: 2A@30 VDC

General Purpose Inputs

- 8xGPIs (Configurable)
 - GPI Functions: RESET/ISOLATE/SILENCE/TEST/MAINS FAULT/BATT. FAULT/POWER FAULT/SENSITIVITY MODE 1/SENSITIVITY MODE 2/SCAN/UDI-1/UDI-2/UDI-4/UDI-5
- *Note: UDI, User Defined Input*

Communication

- RS-485 Network
- Maximum number of devices on Network: 250
- Built in repeater
- Maximum cable length between two adjacent devices: 1.2km
- Support Modbus RTU open protocol

Control

- <Reset>, <Isolate>, <Silence> & <Test> buttons

Display

- 20 segment smoke level bargraph
- 6-digits Numerical LEDs Display
 - Real Time Smoke Level
 - Real Time Airflow Level
 - Device Address
 - Active Event & Codes
- 4 Fire Alarm Indicators
 - Alert, Action, Fire 1, Fire 2
- 4 Fault Indicators
 - Detector, Airflow, System, Auxiliary
- Isolated indicator
- Beeper

Programmer

- Access Password Controlled
- Bargraph and 6-digits 7-Numerical LEDs display the function.
- <Func.> <←><→> <+> <-> <↵> buttons to change settings.

Event Logs

- Number of Events: 25000
- Event Type: Alarm/Fault/Operation/Smoke/Flow/Auxiliary Gas Sensors

Operating Conditions

- Ambient Temperature: 0~40 °C
- Sampling Air Temperature: -20~60 °C
- Humidity: 10~95% RH Non-Condensing

Power

- 24 ±4.8 Vdc
- 620mA (Nominal, Aspirator speed 5)
- 860mA (Maximum, Aspirators speed 10, Alarm Status)

Dimension

- Length=415mm
- Width=259mm
- Height=108mm

Weight

- Net Weight : 5.2kg

Sampling Pipework Design

Aspirating system design is inherently simple. It is often possible to achieve good system performance with very simple installations. There are however a few rules, which must be adhered to, and these rules are equally applicable to all aspirating systems. The information contained in this manual is intended as an overview only. For further information please see the complete Velocity ASD Design Manual.

Considerations

□ Primary Detection Sampling Systems

Are usually arranged to monitor the flow of air movement by the use of pipework and air sampling points mounted directly in the airflow. This type of system is usually regarded as supplementary to other forms of detection due to its limited response capability once the air movement ceases.

In such a system when monitoring a single point of supply or extract, its system sensitivity may be directly related as equal to the sensitivity of the central detector due to the cumulative effect. In the case of a system monitoring more than one point of supply / extract then the system sensitivity will only be determined in discussions with the manufacturer or his representative.

Always locate the sampling points in a position to which smoke may reasonably be expected to travel. This may sound obvious, but, for example, do not expect ceiling mounted sampling points to operate satisfactorily if air flow prevents the cool smoke from an incipient fire from reaching ceiling level. In this instance it is usually better to locate the sampling pipes directly in the airflow (for example in an air conditioning unit air intake). There is no substitute for carrying out smoke tests prior to installation of pipes to indicate suitable sampling point location.

□ Secondary Detection Sampling Systems

Are arranged such that the air sampling points are sited and spaced as if they are point type smoke detectors. They can be positioned to satisfy NFPA 72, NFPA 76, BS 5839-1, BS 6266 and local fire code requirements when the calculated relative sensitivity per air sampling hole equates to a point detector. See Relative Sensitivity below.

□ Maximum Permissible Transport Time

The time taken for a system to transport a sample from a protected area should not exceed 120 seconds (2 minutes). Transport times in excess of this must be the subject of a variation. Shorter

maximum transport times may be desirable in certain applications and should be specified as part of the risk assessment. For example, Class A ASD systems are generally designed with transport times of less than 60 seconds.

Maximum transport time can be directly affected by the installed sample pipe design, see the following Figures. The 4-branch design will provide the shortest transport time.

Single branch system



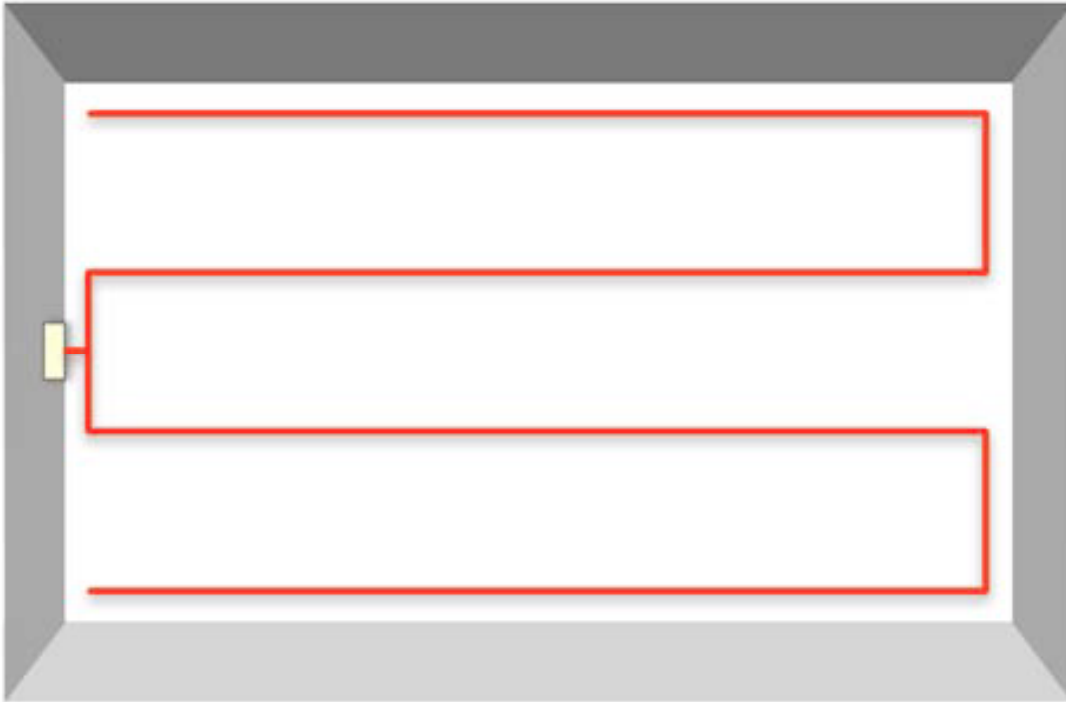

Two branch system

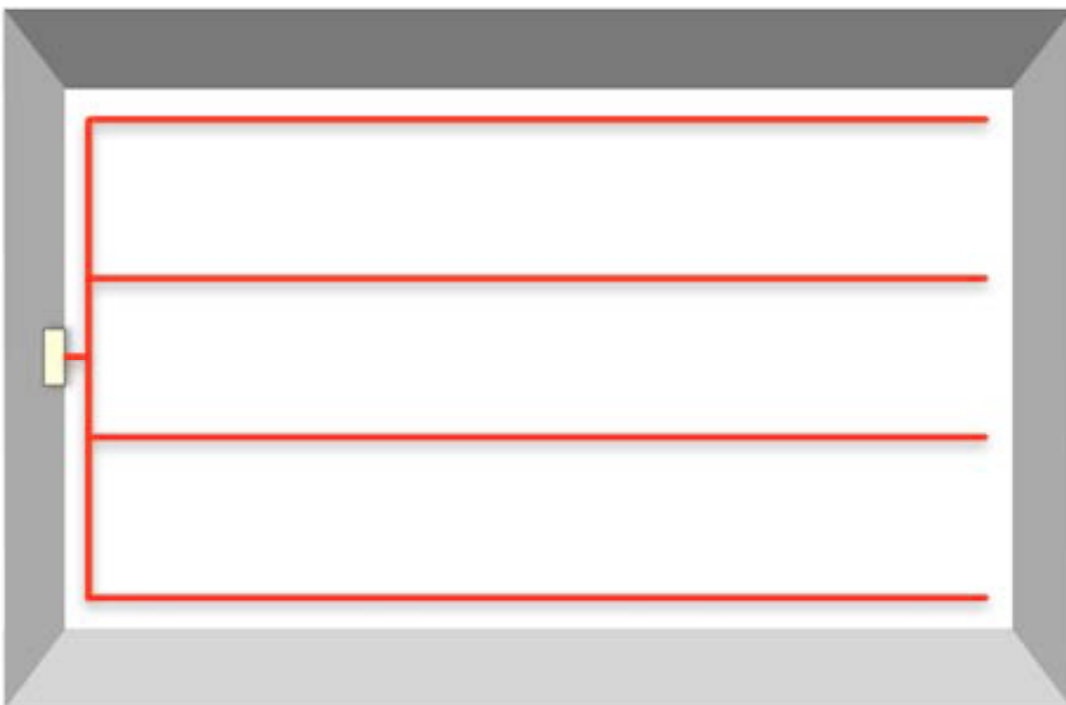

Four branch system



ASD



Sampling Pipe

Balance

Balance is generally expressed as a percentage. If all the sample points have the same amount of air entering each sample hole then this is invariably described as a system with 100% balance.

□ **Relative sensitivity**

The relative sensitivity of each air-sampling hole (assuming that all sampling points have been calculated for an equivalent sensitivity i.e. 100% balance) can be calculated as a simple function of the detector sensitivity and the number of sample points. For example, a 0.1% high sensitivity detection device connected to pipe-work containing 40 equivalent air sampling points can be regarded as a 4%/m system which can be considered as a Class C sensitivity system. Unless otherwise stated in approval documentation a figure of better than 5%/m sensitivity per hole may be applied.

Design Guidelines

- The ideal diameter of sampling pipes is OD: 25mm / ID: 21mm. Other sizes will often work but will provide different response times.
- **Maximum pipework limitation**
The limitation of each pipe inlet of VDOT-ASD-400 when the aspirator speed set to 10 is 100m pipe length with up to 18 holes along the pipe (maximum pipe length) or 60m pipe length with up to 25 holes along the pipe (maximum holes) under the requirement of 120s maximum transport time. There are four pipe inlets for VDOT-ASD-400, so the total maximum pipe length is 4x100m/4x18holes or 4x60m/4x25holes.
 - It is not possible to maximize the pipe length and the number of sampling points at the same time. To maximize the pipe length, the number of sampling holes must be reduced. On the other hand, to maximize the number of the sampling holes on the pipe, the pipe length must be reduced.
- Ideally, if the total length of sampling pipe is greater than 50 meters, then branch pipes should be used. When using branched sampling pipes, care should be taken to achieve a reasonable degree of balance (say within 10% of airflow) to ensure even suction from the pipes.
- Sampling pipes must have capped ends. The end cap should be drilled with a sampling hole normally between 4 or 6mm diameter and free from burrs.
- Sampling holes should normally be 2-4mm diameter or as calculated by ASDFlow and free from burrs.
- This guide holds true for average sampling pipe lengths, but if using long pipes (typically more than 60 meters total), performance may be improved by making the sampling holes near the ends slightly larger than those nearer the detector.
- Although by no means essential, it must be recommended that if in doubt, ASDFlow be used to

ensure that transit times, balance of suction and individual sampling point sensitivity are within desired limits.

- System Sensitivity: The recommended maximum number of sampling holes on the pipework to achieve desired relative sampling hole sensitivity is as follows
 - Class A: 40 holes
 - Class B: 60 holes
 - Class C: 100 holes
- In Consideration of both maximum pipework and system sensitivity, the recommendation of pipe length and number of holes to achieve different sensitivity of VDOT-ASD-400 are
 - EN54-20 Class A: Maximum 40 holes totally
 - 4x100m (4x10 holes)
 - 3x100m (3x13 holes)
 - 2x100m (2x20 holes)
 - EN54-20 Class B: Maximum 60 holes totally
 - 4x100m (4x15 holes)
 - 3x80m (3x20 holes)
 - 2x60m (2x25 holes)
 - EN54-20 Class C: Maximum 100 holes totally
 - 4x60m (4x25 holes)

Installation

Note: It is recommended that the installation is carried out by suitably experienced and trained personnel.

Mechanical Installation

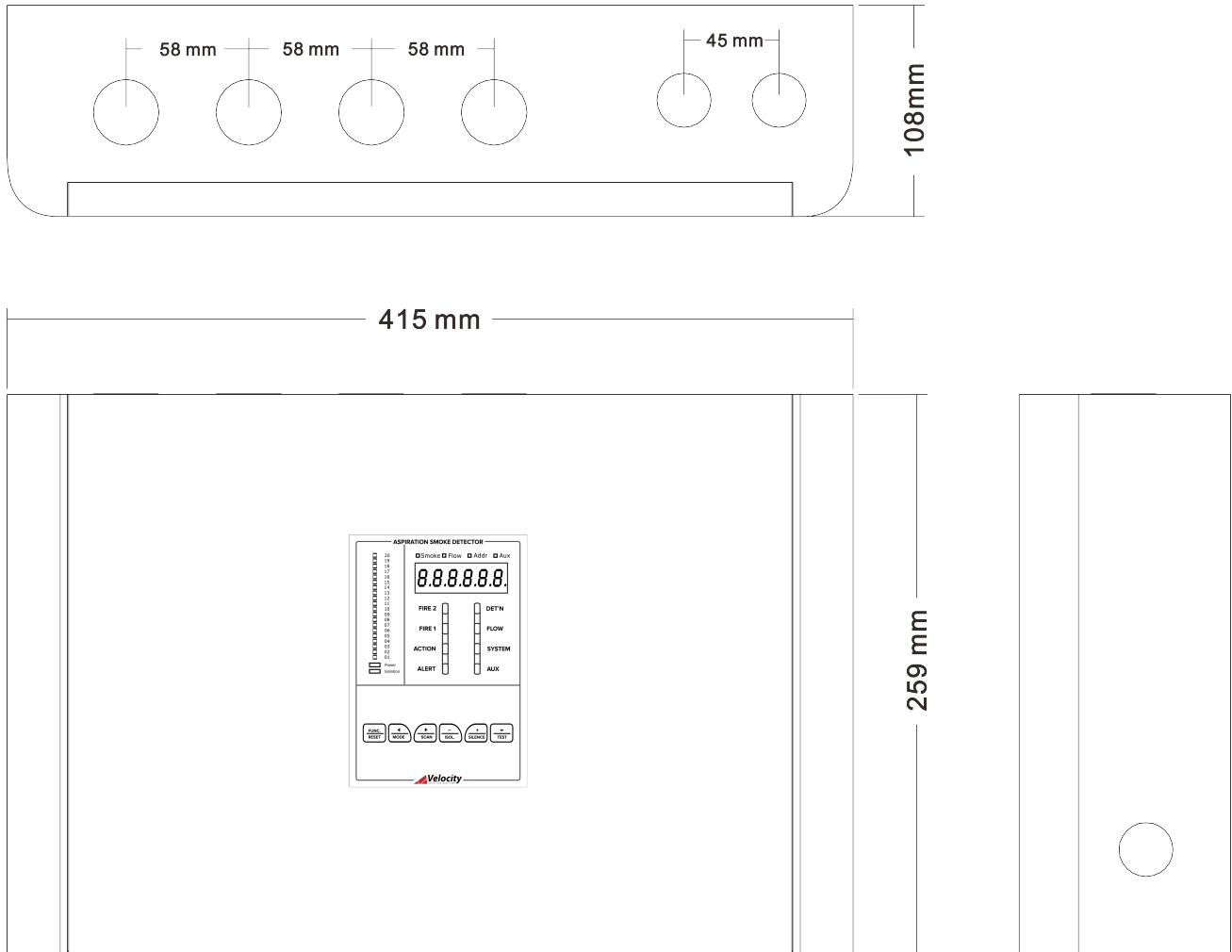

Dimensions

- The mounting holes in each corner are used to mount the device on the wall. It is recommended the device is 1.5m above the floor. The device location should be considered for easy access and suitable for the temperature and humidity operating condition mentioned in the specification.
- Ensure that when the detector is fitted to the wall there is enough space on the right-hand side to allow the opening of the front panel.

Cable entries are also provided on the side and bottom. It should be noticed that some cable entries are non-cut through holes, a punch using a screwdriver and hammer or a proper tool are needed to open the entry holes.

Sampling pipes

Sampling pipes should be made from a non-hazardous material and should be clearly identified. Typical sampling pipes used in air sampling systems are ABS/uPVC pipes with 25mm OD. The pipes should be marked with air sampling or aspirating smoke detection pipe to identify its usage. Red pipe is recommended for it is a fire alarm system.

In some cases, high temperature or corrosion is a concern, metal or other materials suitable materials for that environment can be used.

When drilling holes in the sample pipes, or cutting off lengths of pipe, ensure that all swarf and debris is removed from the pipe.

Electrical Installation

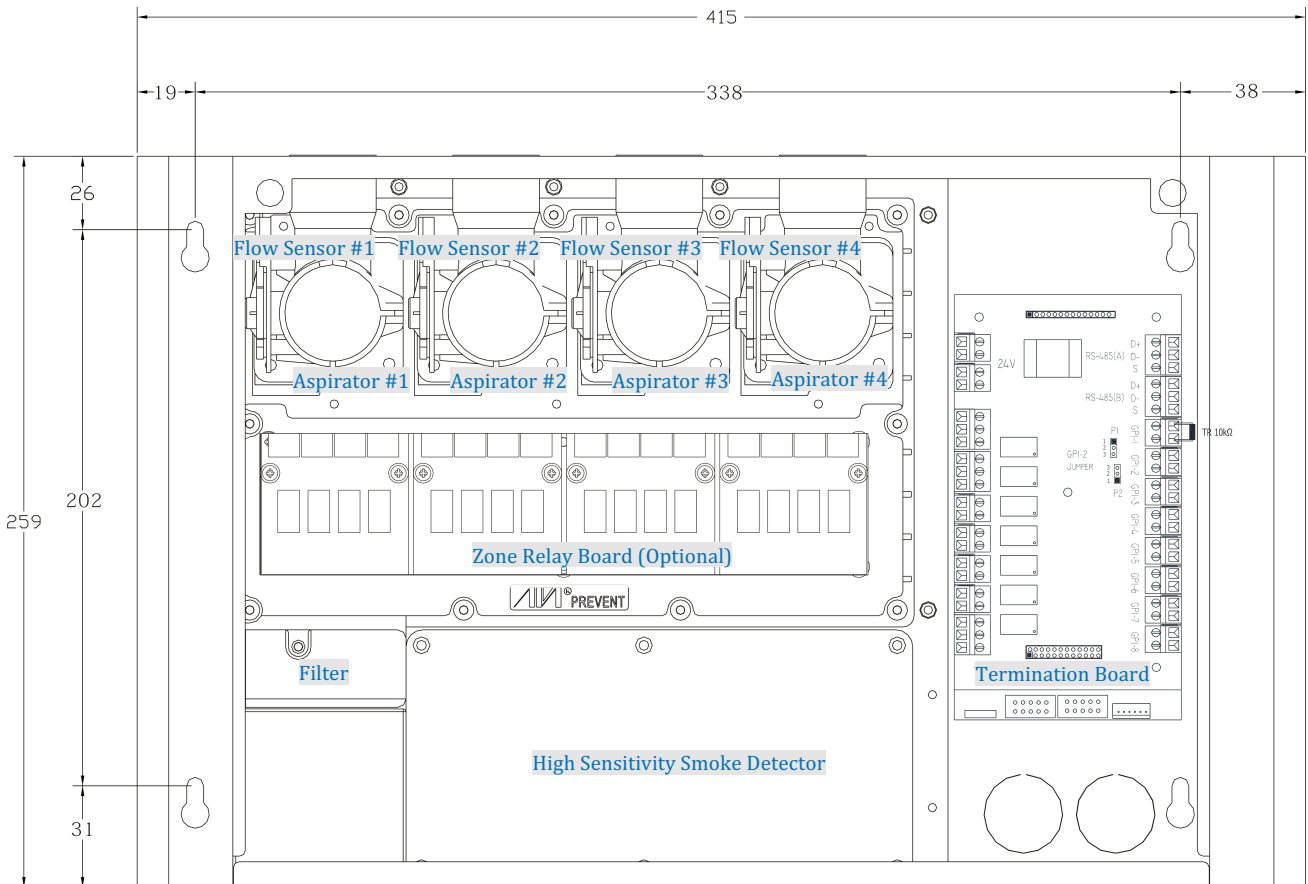

Above picture is the internal view of the VDOT-ASD-400. All the electrical connections should be made to the removable connectors on the termination board or the relay board if it equipped.

Cables

Power cable should be 2.0mm²-2C of sufficient current carrying capacity.

Control cable should be 0.75mm² strands cable.

RS485 network should be 24AWG twisted pair shielded cable.

Terminal Connections

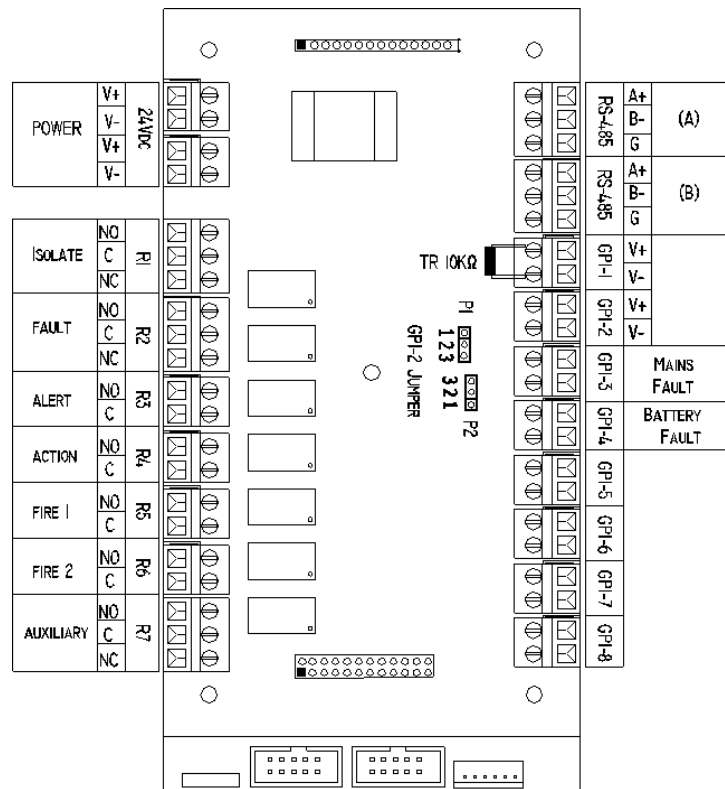

VDOT-ASD-400 Termination Board

❑ Power Supply Connections

There are two 24Vdc power terminals on the termination board. One must be connected to a 24±20% (19.6~28.8) DC Power Supply. The device may be powered by any EN54-4 compliant monitored 24DC power supply of sufficient capacity.

Important Note:

The required 24Vdc primary power and 24 hour standby power for the Detector must be obtained locally from a means suitable for NFPA 72 applications.

❑ Relay Connections

There are 7 configurable relays on the termination board.

- Isolated (NO/NC)
- Fault (NO/NC)
- Alert (NO)
- Action (NO)

- Fire-1 (NO)
- Fire-2 (NO)
- Aux (NO)

Note: NO=Normally Open NC=Normally Closed Com=Common

The relay rating is 2A@30Vdc. If load connected is more than the relay rating, a transfer relay suitable for the rating should be used.

Every relay has its indicator (LED) on board to indicate it's on/off status. It's easy for the user to know the relay status and to trouble shoot if the connected device doesn't go out properly.

All relays are configurable to one of the following functions: Alert, Action, Fire 1, Fire 2, Fault, Isolate, and Auxiliary. The relay output function printed on the termination board is the factory default setting. Users can change the relay function using the front panel display or the Management computer Software to change the setting. However, the second relay, which circuit is designed to normally closed to give a trouble signal when the device is powered off. Care should be taken for the relay's NO or NC connection when changing relay functions.

□ **GPI, General Purpose Input**

There are eight General Purpose Input terminals on VDOT-ASD-400 termination board. Those inputs are designed to monitor the status of the connected devices. The connected devices monitored by the GPI can be just a button, a fault relay from the power supply, or even alarm relay from other detector. Short circuit the pair of the input pins makes ASD to activate associated function defined in the GPI settings. There are 16 possible functions falls in the following categories:

- Device Control: Reset, Isolate, Silence, Test, Scan,

The GPI terminal can be connected to a remote button, a control/output module of the fire alarm system, or a PLC so those control function can be performed remotely, or by other systems.

- Power Fault Monitoring: Mains Fault, Battery Fault, Power Fault

It is sometimes required by local code that the fault status of the mains and/or battery condition of the detector's power supply should be monitored. In this case, the ASD detection device will signal a fault when the connected relay of power supply is activated. The ASD fault

condition can then be monitored by a fire alarm system when its fault relay is connected to the fire alarm system input module.

- Sensitivity Change: Sensitivity Mode 1, Sensitivity Mode 2

In some applications, the detection area environment background smoke level is different in a day. For example, in work hours the background smoke level is usually higher than the non-working hours. Sometimes, outside pollutants go into the detection area can generate false alarm. There are needs to decrease the sensitivity to prevent the false alarm or increase the sensitivity to provide better protection in a daily basis or in certain situations. In this case, the GPI can be connected to a button, a timer, a PLC or even a relay output of other ASD detector sensing the pollutant level from outside, so that that sensitivity adjustment can be made manually or locally.

- User Defined Device Monitoring: UDI-1, UDI-2, UDI-3, UDI-4, UDI-5

The UDI, User Defined Input is usually used to monitor the status (relay) of other detection device, like gas sensors, temperature sensors, or other aspirating smoke detectors.

The GPI-1 on the VDOT-ASD-400 termination board is a monitored contact with a 10KΩ terminal resistor connected at the factory. When the GPI-1 is used, the terminal resistor needs to be moved to the end of the line. When the line connected to the GPI-1 is shorted, the device reports a GPI-1 alarm; when the line connected to the GPI-1 is open, the device reports a GPI-1 fault.

The GPI-2 on the VDOT-ASD-400 terminal board is an active input with monitoring contact, and is disabled by default. To enable the GPI-2, mount both the P1 and P2 jumper selection to 2/3 PIN and set the corresponding GPI function. When the external active input is disconnected for less than 3 seconds, the corresponding GPI-2 function is activated, and when the GPI-2 connection line is disconnected or open for more than 6 seconds, the GPI-2 fault is reported.

□ RS-485

- Two RS-485 Terminals
- Built in RS-485 repeater, the cable length can be extended to next device for another 1.2km.
- RS-485 Network can be configured in closed loop for better communication reliability. The communication can switch direction to communicate with devices behind the failure point when there's device failure, line break or line short circuit.

- Computer Management System (a computer software) can monitor all devices on network.
- SCADA/HMI/PLC systems capable of Modbus RTU open protocol can communicate with ASD devices.

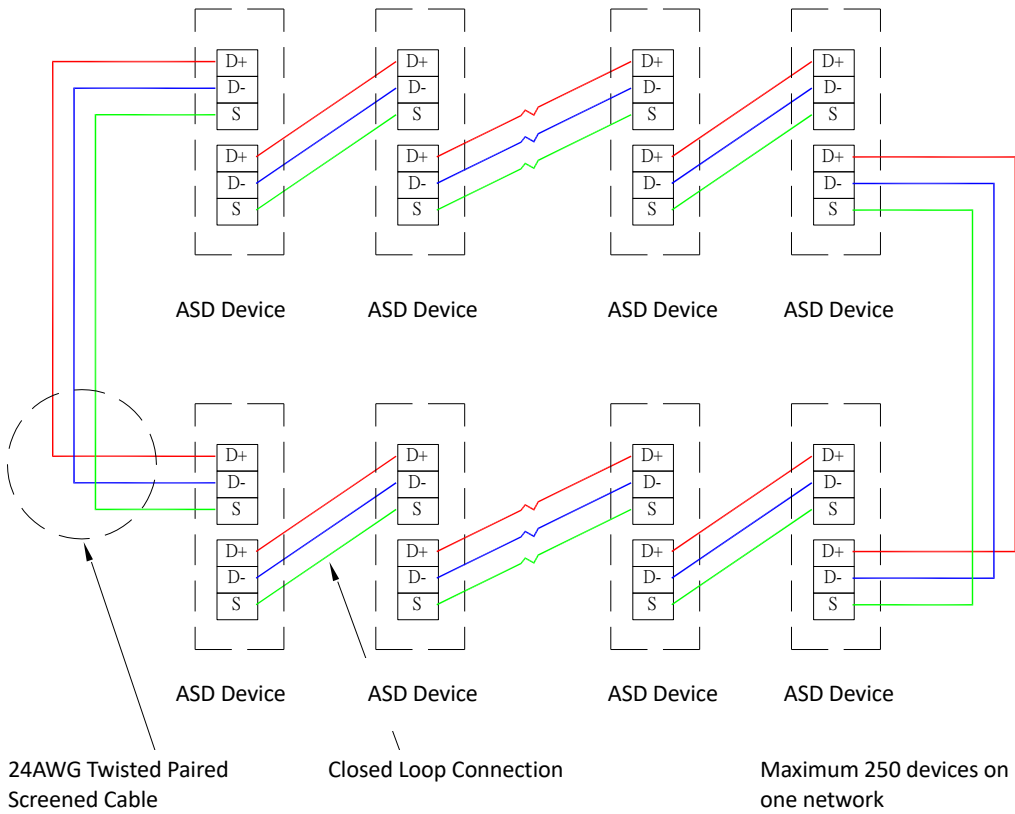

VDOT-NET64 Velocity Aspirating Network Configuration

Front Panel

The VDOT-ASD-400 front panel is a Control / Display /Programmer 3 in 1 LED display.

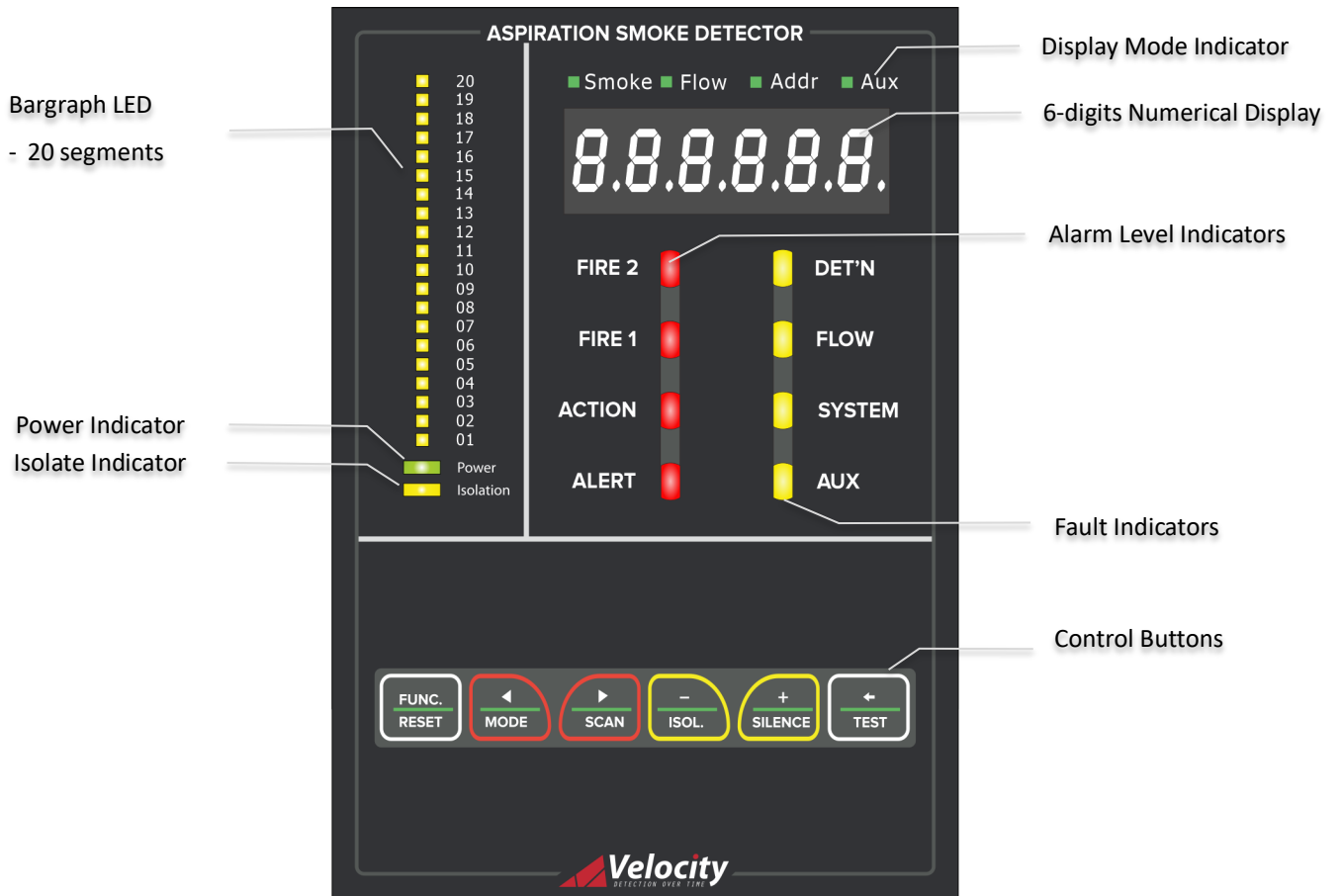

Control

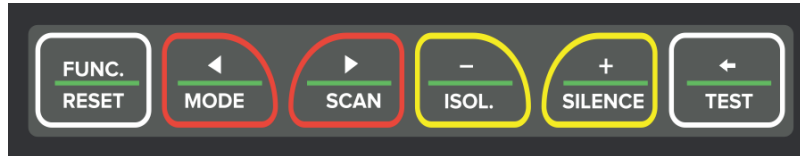

Key	Action	Description
RESET	Press once	Reset, press this key to clear alarms or faults.
ISOLATE/ De-ISOLATE	Press and hold for 2 sec.	The device will be isolated when it was not isolated. It will be de-isolated if it was isolated.
SILENCE	Press and hold for 2 sec.	The beeper will be silenced.
TEST	Press and hold for 2 sec.	All LED indicators on the display will go on for 3 seconds and go off for two seconds as a cycle. The cycle repeats twice for the user to check if there's any malfunction LED.

The difference of SILENCE and ISOLATE is that SILENCE is used to silence the beeper, confirming the alarm or fault status. When there is a new alarm or fault in occurrence the beeper will activate again; while ISOLATE is to completely isolate the system alarm from the corresponding output, there will be NO alarm output when the device is isolated.

Press and hold <RESET> key for 2 seconds shall enter into program mode. For the key function in program mode please see the parameter setting section.

Display

□ Indicators

Indicator (color)	Description
PWR (green)	When the device is powered.
ISOL (yellow)	When the device is isolated
ALERT (red)	When the Alert Threshold has been reached and the appropriate time delays have expired. The detector will generate Alert Alarm.
ACTION (red)	When the Action Threshold has been reached and the appropriate time delays have expired. The detector will generate Action Alarm.
FIRE 1 (red)	When the Fire 1 Threshold has been reached and the appropriate time delays have expired. The detector will generate Fire 1 Alarm.

FIRE 2 (red)	When the Fire 2 Threshold has been reached and the appropriate time delays have expired. The detector will generate Fire 2 Alarm.
DET'N (yellow)	Smoke detection fault
FLOW (yellow)	Airflow Hi/Lo fault, air flow sensor fail, aspirator fail
SYSTEM (yellow)	Except DET'N/FLOW error, all other error is SYSTEM error
AUX (yellow)	Any one of the GPI points on terminal board is in action
Bargraph (yellow)	Display the real-time smoke level, with full scale of Fire 1 Level
	In program mode, individual bargraph LED flashing indicates current parameter no.

Note: The status of the alarm and fault LEDs might not represent current device status. This is because the alarm/fault output will be maintained even when the alarm/fault condition no longer exist if the Alarm Latch or Fault Latch function is enabled. A manual reset will be needed to clear the alarm or fault.

□ 6-digits Numerical LED

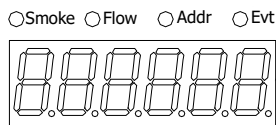

In normal operation, the 6-digit numerical LED displays real-time smoke level, airflow level, device address and current event in occurrence. Press ◀ ▶ buttons on panel could switch the display item in sequence as follows:

Smoke(S) ⇌ Flow(F) ⇌ Address (Addr) ⇌ Auxiliary (Aux)

The 4 indication LEDs above the numerical display indicates which item is displayed. Press ▶ key to switch rightward; press ◀ key to switch leftward.

When switching to Aux, the total number of active events will be displayed first. Press <+> ◊ <-> key will show the detail event message, including date, time and event code. For example, if there are two events: code A0 and E11 exist, it displays 2 when switching to Aux; press <+> will display A0 event message, press <+> again will display E11 event message, and then press <+> to return to the beginning 2. Where, 2 represented total events, A0 is the most updated event, and E11 is the previous event. If <-> is pressed, it will show the event backward. If no active event exists, it displays NONE.

The numerical LED default display is smoke level. If it is switched from the default to other item and without any action in 10 minutes, it will switch back to the default item.

The default display item can be changed by pressing and hold <MODE> key for 2 seconds.

Numerical LED Indicator	Description	
SMOKE	In normal operation, indicates the reading on numerical display is current smoke concentration.	ON
	In program mode, indicates current displayed function is smoke related parameters.	ON
	In executing smoke learning function.	Flashing
FLOW	In normal operation, indicates the reading on numerical display is current airflow percentage.	ON
	In program mode, indicates current displayed function is airflow related parameters.	ON
	In executing flow normalization.	Flashing
ADDR	Display the RS485 address of the device.	ON
AUX.	Display code of current event and code.	ON

Display Item	Numerical LED	unit	Remarks
Smoke (S)	0.000~25.00	%/m	
Airflow (F)	0~200	%	
Address (Addr)	0~255		In setting other parameters, all indicators will go off (except smoke learning or air flow labeled flashing condition)
Auxiliary (Aux)	NONE		
	A1~A14 E0~E33		

The flashing indicators of smoke learning or air flow labeling will not go off due to switching the numerical tube in display. example: In air flow labeling stage, the air flow indicator flashes, if numerical tube switched to display smoke value at this time, the smoke indicator will become normal ON with air flow indicator in flashing; switch to display the air flow value at this time, the air flow indicator will flash; in switching to display temperature, the air flow indicator will flash, temp. Indicator normal ON; the rest may be deduced by analogy, when airflow labeling ended, the air flow indicator will stop flashing.

Beeper

There are the following beeper modes that the beep frequency is different when the device is in alarm or fault status. Users can change the beeper mode according to their application.

Mode	Beeper action
0	Disable the beeper.
1	In alarm, it beeps 1 second in every 10 seconds. In fault, no beep.
2	In alarm or fault, it beeps 1 second in every 10 seconds.
3	In alarm, it beeps continuously. In fault, it beeps 1 second in every 10 seconds.
4	In alarm or fault, it beeps continuously.

□ Event code

Types	Code	Description
Smoke Alarm	A1	Alert
	A2	Action
	A3	Fire 1
	A4	Fire 2
Auxiliary Sensor Alarm	A5	Sensor 1 High Alarm
	A6	Sensor 1 Low Alarm/High High Alarm
	A7	Sensor 2 High Alarm
	A8	Sensor 2 Low Alarm/High High Alarm
	A9	Sensor 3 High Alarm
	A10	Sensor 3 Low Alarm/High High Alarm
	A11	Sensor 4 High Alarm
	A12	Sensor 4 Low Alarm/High High Alarm
	A13	Sensor 5 High Alarm
	A14	Sensor 5 Low Alarm/High High Alarm
Smoke Detection Fault	E1	Smoke Detector Failed
	E2	Smoke Detector Service Required
	E3	Smoke Level High
	E4	Smoke Level Low
Flow Fault	E5	Aspirator Failed
	E6	Flow Sensor Failed
	E7	Pipe Flow High Fault
	E8	Pipe Flow Low Fault
	E9	Normalization Failed
	E17	Filter Blockage
	E18	Filter Removed
	E19	Filter Due
Comms. Fault	E10	Programmer Not Found
	E11	Fan Board Not Found
	E12	Zone Relay Board Not Found
	E13	HSSD Not Found
	E14	Auxiliary Sensor Board Not Found
System Fault	E20	Power Fault
	E21	Battery Fault
	E22	Mains Fault
	E23	RTC Fault

	E24	Sensitivity Mode Confliction
Auxiliary Sensor Fault	E25	Sensor 1 Failed
	E26	Sensor 2 Failed
	E27	Sensor 3 Failed
	E28	Sensor 4 Failed
	E29	Sensor 5 Failed
Learning	E31	Flow Normalization
	E32	Smoke Background Learning
Isolation	E30	Device Isolated
	E33	Zone Isolated

Display panel has integrated control/ programming that when in operating mode, the key function on panel is able to execute REST/ISOLATE/SILENCE/TEST function as well as to display the figure of Smoke/Flow/Addr/Evt by numerical tube; while in setting mode, the setting of related operating parameters of detecting device can be done via keypad/ Bargraph/ numerical tube.

Table: Summary of key function under operating mode

Key pad	Key Action	Description
FUNC.	Press and hold for 2 sec.	In operating mode, enter into program mode
RESET	Press once	Reset
◀	Press once	Numerical LED display item switch leftward
MODE	Press and hold for 2 sec.	Numerical LED display default item. The default item will be switched rightward to the next item.
▶	Press once	Numerical LED display item switch rightward.
SCAN	Press and hold for 2 sec.	Manual starts the pipe scan process.
+		
ISOL	Press and hold for 2 sec.	Isolated
-		
SILENCE	Press and hold for 2 sec.	Mute
↵		
TEST	Press and hold for 2 sec.	Display LED test

Parameter Setup

- ◆ Press and hold <Func.> key for 2 sec. under operating mode and enter into parameter setting mode, the Bargraph 01 indicator flashes and shows in setting 01 parameter with numerical tube displaying the parameter value of 01. If parameter password function was set at 1(ON), password would be required before editing parameters, or else it is sole displaying without editing. If password was set to 0(OFF), direct editing parameters is possible after entering.
- ◆ Editing parameters: press +/-key to alter parameter value; adjust it to the proper figure and press and hold return key for 2 sec. to store; the numerical tube display will flash 3 times if

successfully stored. Note: if password setting to 1(ON) but without entering password or wrong password was entered, press +/- will cause no reaction.

- ◆ Bargraph grid represents parameter no., ex. Enter parameter 15 will lead 15th Bargraph grid starts to flash. Enter parameter 21 will lead 20th and 01 Bargraph grid in flashing, the rest may be deduced by analogy...
- ◆ If setting value exceeds the range permitted (i.e. fan rpm exceeds max., A1 valve value higher than A2, etc.), detector will judge automatically and jump to the max. value in next range.
- ◆ Press and hold F key for 2 sec. to exit the setting mode.
- ◆ If no action taken for 1 min. under setting mode, it will count down by 10 sec. in exiting the setting mode.

Table: key function under program mode

Key pad	Pressing key	Execution
FUNC	Press and hold for 2 sec.	In program mode, exit program mode
Reset		
◀	Press once	Return to the previous parameter
▶	Press once	Move to next parameter
-	Press once	Reduce displayed value. When the value reaches the minimum, press <-> key will to to the maximum value.
	Press and hold	Fast reducing displayed value
ISOL		
+	Press once	Increase the displayed value. When the value reaches the maximum, press <+> key will jump to the minimum value.
	Press and hold	Fast increasing displayed value
SILENCE		
↵	Press and hold for 2 sec.	Save setting, the numerical LED will flashes 3 times if successfully saved.
TEST		

Parameter Functions

Item	Menu	Parameter	Lead No.	Min	Max	Dft	Description	Access Level
1	Alarm Level & Delay	Full Scale Sensitivity	AF.	0.01	20.0	0.20	The detector smoke level in %/m for the bargraph reaching its full scale (20 bars). The smaller the value, the higher the sensitivity is or vice versa.	ADM
		Alert Bargraph Level	A1.	2	20	10	The Alert "bargraph" level. When the alert bargraph level has been reached and the appropriate time delays have expired. The detector will generate Alert Alarm. The Alert Smoke Level (%/m) = Full Scale Level/20 x Alert Bargraph Level. For examples, by the default settings, the alert level is $0.2/20 \times 10 = 0.1\%/m$.	
		Action Bargraph Level	A2.	3	20	15	The Action "bargraph" level. When the action bargraph level has been reached and the appropriate time delays have expired. The detector will generate Action Alarm. The Action Smoke Level (%/m) = Full Scale Level/20 x Action Bargraph Level. For examples, by the default settings, the action level is $0.2/20 \times 15 = 0.15\%/m$.	
		Fire 1 Bargraph Level	A3.	20	20	20	The Fire 1 "bargraph" level. When the fire 1 bargraph level has been reached and the appropriate time delays have expired. The detector will generate Fire 1 Alarm. This setting is fixed to 20 and cannot be modified.	
		Fire 2 Level	A4.	0.10	20.0	2.00	The Fire 2 "smoke" level in %/m. When the smoke level has been reached and the appropriate time delays have expired. The detector will generate Fire 2 Alarm.	
		Alert Delay	t1.	0	60	30	The alarm delay is the number of seconds that an alarm level has to be continuously sensed before the alarm is initiated. Each alarm level has a programmable delay of between 0 and 60 seconds.	ADM
		Action Delay	t2.	0	60	20		
		Fire 1 Delay	t3.	0	60	10		
Fire 2 Delay	t4.	0	60	10				
3	Pipe Flow	Pipe Used	U.	0	1	1	Enable if the pipe is connected. It is used to enable or disable flow sensing on the specified pipe inlet of the detector. If any pipe inlets are unused, set the relevant flow sensor function for the pipe inlet to No to avoid unwanted flow faults.	ADM
		Pipe Flow High	H.	101	200	120	Flow high is the level above which airflow needs to increase to trigger a fault indication (which may indicate a loose or damaged inlet pipe)	
		Pipe Flow Low	L.	0	99	80	Flow low is the level below which airflow needs to be reduced to trigger a fault reading (which may indicate a blocked pipe)	
		Pipe Fan Speed	F.	0	10	5	The value entered sets the aspirator in the detector to one of a range of predetermined speeds. The lower the number entered the lower the airflow rate and the lower the power consumption.	
		Flow Sensitivity	S.	0	5	0	The flow detection sensitivity increase with the set number.	DST
4	Normalize Flow	Normalize	NA.	N	Y	N	Setting this function to Y puts the detector into automatic flow normalization process. This takes a few minutes to normalize the flow to 100% based on the current flow rates. During normalization, the green flow indicator (LED) on VDOT-ASD-400 display will flash. After normalization, the flow reading greater than 100 means the current flow is bigger than normal condition.	DST

							<p>indicating a sign of pipe breakage. On the other hand, the flow reading less than 100 means the current flow is smaller than normal condition, indicating a sign of pipe or sampling port blockage.</p> <p>Note: It is crucial to make sure no breakage or blockage on the pipe before setting the device into normalization process. Otherwise the system will see the abnormal condition as a normal condition.</p>	
		AutoNorm.	NF.	N	Y	Y	Setting this function to Y will automatically go into normalization process when the device is powered on.	
5	Alarm Action	Cascade Alarm	CA.	N	Y	Y	<p>Setting this function to Y means that only when the detector's controller has gone into Alert does the controller start counting down the Action delay i.e. the time delays on Alert and Action are cumulative. So are the following Fire 1 and Fire 2 delays.</p> <p>There are chances that the higher level alarm goes off before the lower level alarm if the setting of higher level alarm time delay is less than the time delay of lower level alarm and the smoke level increase quickly. Enable cascade alarm will guarantee the alarms go off step by step.</p>	ADM
		Alarm Latch	AL.	N	Y	Y	When this function is set to Y it requires a reset on the front panel or a remote reset to clear an alarm condition. This means the alarms must be confirmed and reset manually even if the smoke level is decreased below alarm level. This is the factory default setting. When this function is set to N, the alarm will be reset automatically when the smoke level is decreased below alarm threshold.	
		Fault Latch	FL.	N	Y	N	When this function is set to Y it requires a reset from the front panel or a remote reset to clear fault indications. If this function is set to N, the fault will be reset automatically when the fault condition is cleared.	
		Fault Delay	Ft.	0	60	10	The fault delay is the number of seconds that a fault condition has to be continuously sensed before the fault is initiated.	
6	Filter	Filter Status	FS.	0	100		Read Only	
		Filter Due	Fd.	0	730		Read Only	
		New Filter	FN.	N	Y	N	Setting this function to Y to start a new filter life cycle when a new filter has been installed	DST
7	Front Panel	Reset Button	dr.	N	Y	Y	The front panel buttons may be enabled or disabled individually by setting these functions to Y or N.	ADM
		Isolate Button	dl.	N	Y	Y		
		Silence Button	dS.	N	Y	Y		
		Test Button	dt.	N	Y	Y		
		Beeper	db.	0	4	3	<p>The front panel beeper has different mode when it is set to the following number:</p> <p>0: Disable the beeper, no sound in case of alarm or fault.</p> <p>1: In alarm, the beeper sounds one second in every 10 seconds. In fault, the beeper will not sound.</p> <p>2: In alarm and fault, the beeper sounds one second in every 10 seconds.</p> <p>3: In alarm, the beeper sound consistently. In fault, the beeper sounds one second in every 10 seconds.</p> <p>4: In alarm and fault, the beeper sound consistently.</p>	
8	Control	RESET	Cr.	N	Y	N	This has the same effect as pressing the <RESET/ISOLATE/SILENCE/TEST> buttons on the front panel.	ADM
		ISOLATE	Cl.	N	Y	N		
		SILENCE	CS.	N	Y	N		

		TEST	Ct.	N	Y	N		
9	GPI	GPI-1	I1.	0	15	1	<i>Setting the GPI terminal to below functions:</i> 0: NOT USED 8: SENSITIVITY MODE 1 1: RESET 9: SENSITIVITY MODE 2 2: ISOLATE 10: SCAN (VDOT-ASD-400 Only) 3: SILENCE 11: UDI-1 4: TEST 12: UDI-2 5: MAINS FAULT 13: UDI-3 6: BATT. FAULT 14: UDI-4 7: POWER FAULT 15: UDI-5	DST
		GPI-2	I2.	0	15	2		
		GPI-3	I3.	0	15	5		
		GPI-4	I4.	0	15	6		
		GPI-5	I5.	0	15	0		
		GPI-6	I6.	0	15	0		
		GPI-7	I7.	0	15	0		
		GPI-8	I8.	0	15	0		
10	Device Relay Configuration	Relay 1	r1.	1	7	1	<i>This sets the termination board relays to below output:</i> 1: ISOLATE 2: FAULT 3: ALERT 4: ACTION 5: FIRE 1 6: FIRE 2 7: AUXILIARY Note: Relay 2 is Normally Closed the others are Normally Open.	DST
		Relay 2	r2.	2	2	2		
		Relay 3	r3.	1	7	3		
		Relay 4	r4.	1	7	4		
		Relay 5	r5.	1	7	5		
		Relay 6	r6.	1	7	6		
		Relay 7	r7.	1	7	7		
11	Zone Relay Configuration	Relay 1	01.	2	2	2	<i>Relay 1~4 is Zone 1 outputs</i> <i>Relay 5~8 is Zone 2 outputs</i> <i>Relay 9~12 is Zone 3 outputs</i> <i>Relay 13~16 is Zone 4 outputs</i> <i>The relay configuration is the same as device relays.</i> 1: ISOLATE 2: FAULT 3: ALERT 4: ACTION 5: FIRE 1 6: FIRE 2 7: AUXILIARY Note: Relay 1/5/9/13 are Normally Closed the others are Normally Open.	DST
		Relay 2	02.	1	7	3		
		Relay 3	03.	1	7	4		
		Relay 4	04.	1	7	5		
		Relay 5	05.	2	2	2		
		Relay 6	06.	1	7	3		
		Relay 7	07.	1	7	4		
		Relay 8	08.	1	7	5		
		Relay 9	09.	2	2	2		
		Relay 10	10.	1	7	3		
		Relay 11	11.	1	7	4		
		Relay 12	12.	1	7	5		
		Relay 13	13.	2	2	2		
		Relay 14	14.	1	7	3		
		Relay 15	15.	1	7	4		
		Relay 16	16.	1	7	5		
12	Device Relay Test	Relay 1	r1.	N	Y	N	<i>When the selected relay is set to Y or N, the relay will be activated or de-activated to check if the relay connected device action is correct. For example, If relay 5 is fire 1 and connected to fire alarm system. Setting relay 5 to Y should have proper indications on the fire alarm panel.</i> Setting All (All Relays) to Y, all relays will be activated.	ADM
		Relay 2	r2.	N	Y	N		
		Relay 3	r3.	N	Y	N		
		Relay 4	r4.	N	Y	N		
		Relay 5	r5.	N	Y	N		
		Relay 6	r6.	N	Y	N		
		Relay 7	r7.	N	Y	N		
		All	AL.	N	Y	N		
13	Zone Relay Test	Relay 1	01.	OFF	ON	OFF	<i>When the selected relay is set to Y or N, the relay will be activated or de-activated to check if the relay connected device action is correct. For example, If relay 5 is fire 1 and connected to fire alarm system. Setting relay 5 to Y should have proper indications on the fire alarm panel.</i> Setting All (All Relays) to Y, all relays will be activated.	ADM
		Relay 2	02.	OFF	ON	OFF		
		Relay 3	03.	OFF	ON	OFF		
		Relay 4	04.	OFF	ON	OFF		
		Relay 5	05.	OFF	ON	OFF		
		Relay 6	06.	OFF	ON	OFF		
		Relay 7	07.	OFF	ON	OFF		
		Relay 8	08.	OFF	ON	OFF		
		Relay 9	09.	OFF	ON	OFF		
		Relay 10	10.	OFF	ON	OFF		
		Relay 11	11.	OFF	ON	OFF		
		Relay 12	12.	OFF	ON	OFF		
		Relay 13	13.	OFF	ON	OFF		
		Relay 14	14.	OFF	ON	OFF		
		Relay 15	15.	OFF	ON	OFF		
		Relay 16	16.	OFF	ON	OFF		

	All	AL.	OFF	ON	OFF			
14	Date & Time	YYYY/Year	yy.	2000	2099	2010	<i>It is important that the time and date be set up correctly on the controller's internal calendar/clock because it uses this information to store events in the event log.</i>	ADM
		MM/Month	NN.	01	12	05		
		DD/Day	dd.	01	31	18		
		HH/Hour	HH.	01	23	19		
		MM/Minute	nn.	00	59	36		
		SS/Second	SS.	00	59	0		
15	System	Address	Ad.	1	250	250	<i>Setting the device RS485 address. A device must have a unique address on the network.</i>	ADM
		Factory Default	dF.	N	Y	N	<i>Setting the function to Y will restore the device to the factory default settings. However, the device address will not be affected to prevent from unwanted network error.</i>	DST
		Password	PS.	N	Y	Y	<i>When this function is set to Y it requires a password to enter the Program Mode and has the right to change settings. Setting this function to N it requires no password to enter the Program Mode and can only view the settings.</i>	
		Reference Detector Address	rA.	0	250	0	<i>Setting the reference detector address number between 1 and 250 to enable referencing. When this function is set to 0 the referencing is disabled.</i>	
		Reference Zone	rP.	1	8	1	<i>The zone (detector) number of above reference detector address.</i>	
		Reference Dilution	rd.	1	100	100	<i>The value set with this function is the percentage reference signal subtracted from the detector's signal, if a reference device has been allocated.</i>	
		Reference Delay	rt.	0	100	0	<i>This value is the delay time (in seconds) between a build up of pollution being seen by the reference (if used) and the pollution being seen by the detector.</i>	
16	Log	Smoke Log Enable	SN.	N	Y	Y	<i>Setting this function to Y enables the smoke/flow log. There are two selectable log modes, CHANGE and RATE. On VDOT-ASD-400, 0 is CHAGNGE and 1 is RATE. When the log mode "CHANGE" is selected the following change function sets the following change percentage of the detection full scale: 0.01%, 0.05%, 0.1%, 0.2%, 0.5%, 1%, 2%, 5% When the log mode "RATE" is selected the following function sets the following log rate in seconds: 1, 10, 60, 300, 600, 1200, 1800, 3600 Note: For the smoke change, the detection full scale is the bargraph full scale, which is the same as Fire 1 Level. For the flow change it's 200%, the maximum flow reading in percentage.</i>	ADM
		Smoke Log Mode	SL.	0	1	0		
		Smoke Change/Rate	SC. /St.	0.01/1	5/3600	5/3600		
		Flow Log Enable	FN.	N	Y	Y		
		Flow Log Mode	FL.	0	1	0		
		Flow Chang/Rate	FC. /Ft.	0.01/1	5/3600	5/3600		
17	Scale	Mean Period	rt.	15	480	60	<i>This value is the period used to calculate the mean of smoke background level in this period. The mean period is selectable between the following values in minute: 15, 60, 12, 240, 480</i>	DST
		Sensitivity Mode 1	S1.	0.1	10.0	1.0	<i>Setting this function to increase or decrease the smoke detection sensitivity by multiple this value to the original smoke alarm thresholds when relevant GPI is activated. This setting must work with the GPI which is set to Sensitivity Mode 1 or 2. If this function value is set to be greater than 1.0, the smoke detection becomes more sensitive. On the other hand, it becomes less sensitive if this function value is set to less than 1.0. This function is usually used when different smoke detection sensitivity is required in certain situations. For example, in work hours the smoke background level increases due to all kinds of production activities. It may be desirable to have lower sensitivity in work hours and</i>	
		Sensitivity Mode 2	S2.	0.1	10.0	1.0		

							<i>have higher sensitivity in non-working hours. Or when there're pollutants outside the detection zone causing false alarms, it can be solved by decrease the sensitivity by using another ASD device to detect the pollutant level and connect its relay to the GPI of the ASD device in the detection zone.</i>	
18	SW Version.	Controller	SC.				<i>Read Only</i>	USR
		Display	Sd.				<i>Read Only</i>	
		Serial No.	SN.				<i>Read Only</i>	
19	Scan	Scan Enable	SE.	OFF	ON	OFF	<i>Enable VDOT-ASD-400 Pipe Scan Function</i>	MFG
		Scan Level	SL.	1	4	3	<i>The alarm level reached to start pipe scan process to identify the pipe with most smoke. 0=Manual Only, 1=Alert, 2=Action, 3=Fire 1, 4=Fire 2</i>	ADM
		Scan Time	St.	5	60	20	<i>The time in seconds for the aspirator operate on each pipe.</i>	
20	Optional Module	Zone Used	OP.	OFF	ON	ON	<i>Enable/Disable Zone</i>	DST
		Display Used	Od.	OFF	ON	ON	<i>Enable/Disable Display/Programmer</i>	
		Filter Used	OF.	OFF	ON	OFF	<i>Enable/Disable Filter</i>	
		Sensor Used	OS.	OFF	ON	OFF	<i>Enable/Disable optional Sensor Board</i>	
		Zone Relay Used	Or.	OFF	ON	OFF	<i>Enable/Disable optional Zone Relay Board</i>	

Commissioning

Before commissioning the detector, the local standards of aspirating detection systems must be consulted. These standards differ widely throughout the world and specific advice for the market in one country may not be applicable to another.

Commissioning strategy will initially depend upon the environment in which the detector is installed. For instance, the test for a computer room (which should be a relatively clean environment) would be very different from, say, a tobacco factory, which would probably have a high level of airborne particulate content.

A widely accepted standard for computer rooms/IDC areas is British Standard BS6266 and also the NFPA 76, equipment overheating at a stage well before combustion. To perform the test electrically overload a 1-meter length of PVC insulated wire of 10/0.1mm gauge for one minute using an appropriate power supply. The detector has two minutes from the end of the wire burn to give an alarm indication.

For areas with higher levels of background particulate matter testing methodology would be similar to that of standard point detectors.

Commissioning Check List

The following brief checklist allows quick setup of the detector. This procedure will be adequate for most standard installations.

- Before powering up the detector, visually check all cabling to ensure correct connection. If wire identification is not immediately clear (e.g. by use of different colored wires or wire identification sleeves) an electrical check should be made. Any damage caused by misconnection of the detector is not covered by warranty.
- Power up the unit and enter the engineering access code.
- Enter the Setup menu and verify that the time and date are correct.
- Set the appropriate alarm levels and time delays for the protected environment.
- Modify necessary settings in your application and exit program mode.
- Introduce smoke to every pipe end to make sure the maximum transport time is within specification. Typical maximum transport time per NFPA 72 is 120 seconds. Other transport time requirement should be specified considered in the design stage.
- Perform any necessary smoke tests, like Hot Wire performance test or Potassium Chlorate / Lactose performance test, ensuring that the detector reacts appropriately, and let the smoke fully dissipate.

Note:

1. If the device is connected to Management System Software, the date and time can be synchronized to the computer date and time. All the devices on the network can be synchronized by Management System Software at the same time.
2. Set the time delays temporarily to 0 second when testing the transport time is appropriate to eliminate the alarm delay time in counting the response time. However, the time delays should be set to its appropriate value after the tests.
3. The maximum transport time may be specified to 90 or 60 seconds when early warning or very early warning fire detection is the required performance.

Maintenance

VDOT-ASD-400 aspirating smoke detector is a very low maintenance detection system. If required, external cleaning of the unit should be performed using a damp (not wet) cloth. Do not use solvents as these may mar the display bezel. The only part that may require field replacement during servicing is the dust filter. The filter condition can be checked from the Display, which gives a percentage reading of filter efficiency and the filter expired due date. When the level drops to 70% or the date is due the detector will signal a Filter renew fault and the filter will need replacing.

The following illustration shows how the dust separator is replaced.

Open the front cover using the key provided, and locate the filter at the bottom of the detector as shown. Untighten the screw in the middle of the filter to remove the filter. Fit a new filter, make sure to push the filter fully home and tighten the screw.

When the replacement filter is fitted, enter the setup menu to set a new filter. When new filter is set, a filter flow calibration process will be initiated to learn the flow rate passing through the new filter. The filter due date will also be set to two years from the date changing the new filter.

Preventive Maintenance

To guarantee the best performance of VDOT-ASD-400 aspirating detection system, a periodic preventive maintenance is required. The PM schedule is as follows:

Content \ Time	Monthly	Quarterly	Every 6 months	Every year	Every two years
Power Supply Check	V	V	V	V	V
Display Check	V	V	V	V	V
Air Flow Check	V	V	V	V	V
End Cap Test		V	V	V	V
Sampling pipes inspection			V	V	V
Signaling inspection				V	V
Clean sampling pipework					V

There are monthly inspection, quarterly inspection, 6 months inspection, yearly inspection and two years inspection schedules for the VDOT-ASD-400 aspirating smoke detection systems. It is recommended that monthly inspection is done by the user and all the others are performed by the trained professional personnel or companies.

It should be checked that there have been no unauthorized changes to the system configuration (e.g. Sensitivity). If changes are required or have taken place, then these must be documented.

Check the Power Supply (UPS)

- a. Check the DC input voltage using a meter to make sure the power is within normal range.

Check the Device Display

- a. Press the <Test> button (if it's enabled) to check if all the LEDs on the display illuminates normally.

Check the Air Flow

- a. Use VDOT-ASD-400 front panel display or Management System computer software to check and record the airflow readings.
- b. Compare the reading to history record to see if there's significant change. Airflow reading during maintenance should be confirmed as $\pm 20\%$ of the values measured at commissioning
- c. Inspect the sampling pipe to see if there is pipe breakage or hole blockage if there's significant change in readings.

End Cap Smoke Test

- a. Introduce smoke to the pipe end.
- b. Check the response time is within specification (typically 120 seconds) and compare this to history record. Measurements of transport time from the furthest hole during maintenance should be confirmed to be within $\pm 15\%$ or ± 3 seconds, whichever is the greater, of the same measurement taken at commissioning.
- c. Inspect the pipework if there's significant change in the response time.

□ **Sampling Pipes Inspection**

- a. Check there's no obstructions to sampling pipework, sampling points and/or remote capillaries.
- b. Visual check there's no pipe breakage or sampling point blockage.
- c. Check the capillary tube if it is loosed from the connector of the remote sampling point.

□ **Signaling Inspection**

To verify the connections between VDOT-ASD-400 and other connected systems (e.g. CIE, BMS).

- a. Activate the fire relays in the relay test menu or introduce smoke to put the detector into alarms to check if there's associate alarm generated on the fire alarm panel if it's connected to the fire alarm system.
- b. Activate the fault relay in the relay test menu or put the detector into fault (e.g. pull out the sampling pipe to generate flow fault) to check if there's associate fault generated on the fire alarm panel if it's connected to the fire alarm system.
- c. Shut down the power supply mains power. Check if the power supply back up output and its display function correctly. Check if there's relevant fault generated on VDOT-ASD-400 device if the mains or power fault monitoring GPI is connected. Check if there's relevant fault generated on fire alarm panel if the fault relay is connected to fire alarm system.
- d. Disconnect the negative wire (black) of the power supply batteries. Check if the power supply and its display function correctly. Check if there's relevant fault generated on VDOT-ASD-400 device if the battery or power fault GPI is connected.

□ **Clean the sampling pipework**

- a. The sampling point can be cleaned using a proper tool (e.g. a tooth pick or sharp needle) to remove the dust build up on the sampling hole.
- b. To clean the capillary tube, it can be removed from the pipe and use compressed air to blow the dust away.
- c. To clean the whole sampling pipework system, a sampling pipe must be removed from the pipe inlet and introduce high airflow providing by a compressor into the sampling pipe to blow off

the dust in the pipework and the sampling holes. Alternatively, to ease the maintenance, a three ways valve can be installed before the pipe inlet so that a maintenance inlet is provided on the three ways valve. In normal operation, the valve is switched to connect the sampling pipe and the detector pipe inlet. In maintenance occasion, it is switched to connect the sampling pipe and the maintenance inlet so that the high airflow can be introduced to the maintenance inlet directly.

Appendix

Pipe Scan

VDOT-ASD-400 aspirating smoke detector consists of four individual aspirators, connecting to its pipe inlet port and one high sensitivity smoke detector. All the air samples from the four pipes are mixed and go to a single exhaust port. The mixed air samples are then drawn into the high sensitivity smoke detector on the way to the exhaust port.

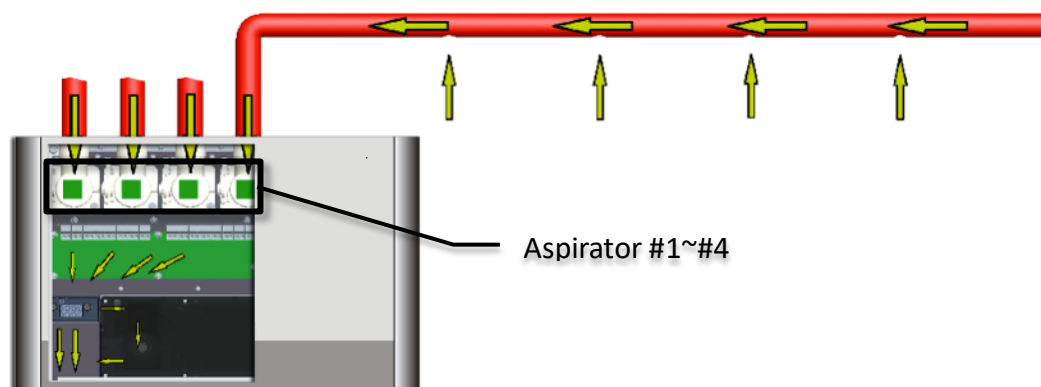

Taking advantage of the four individual aspirators, the VDOT-ASD-400 can turn each aspirator on and off in sequence when there is a smoke alarm to “identify” the pipe having the most smoke. We call this process pipe scan.

For example, when there's smoke goes into the sampling points on pipe 3, the VDOT-ASD-400 will detect the smoke and generate alarms when the smoke alarm levels have been reached and appropriate time delay expired. At this time, the VDOT-ASD-400 cannot identify which pipe the smoke is from. When the alarm reaches the scan level setting (can be alert, action, fire 1, or fire 2), besides the activation of alarm LED on the display and relay output on the termination board, the pipe scan process will be activated.

The scan process starts to scan pipe 1 (turn on fan 1 and turn off fan 2, 3, 4), collect the smoke level for pipe 1 for a time interval call scan time. When the pipe 1 scan time is completed, it will move to scan pipe 2 (turn on fan 2 and turn off 1, 3, 4) and then scan pipe 3 and scan pipe 4 respectively, finally all the fans will turn on to flush out the possible smoke contained inside the detector and then complete a pipe scan cycle. During the scan process the 6 digits Numerical Display will flash and show the scanned pipe number and its smoke level. After the scan cycle, the smoke data of each pipe is calculated and analyzed, and the pipe with the most smoke will be identified. The

outcome of the scan will be shown on the display event log and the alarm relay on the Zone Relay Board will be activated. The scan process example of a pipe 3 fire is shown on the following illustration.

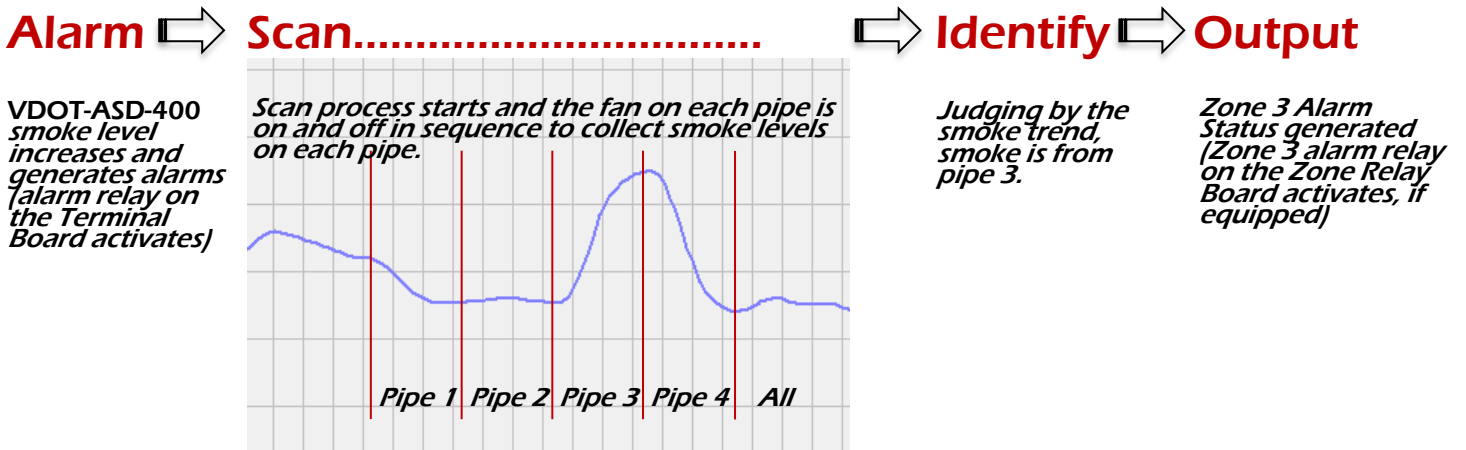

There's possibility that the scan process is failed due to the result of smoke data calculation, no pipe data is significant enough for the identification. In this case, the scan cycle will start again. If the second scan cycle also failed, the scan will stop and no result will be generated.

□ Pipe Scan Function Settings

Item	Menu	Function	Leading No.	Min.	Max	Default	Description	Auth.
19	Pipe Scan	Enable	SE.	OFF	ON	OFF	<i>Enable VDOT-ASD-400 Pipe Scan Function</i>	Mfg
		Scan Level	SL.	0	4	0	<i>The alarm level reached to start pipe scan process to identify the pipe with most smoke. 0=Manual Only, 1=Alert, 2=Action, 3=Fire 1, 4=Fire 2</i>	Adm
		Scan Time	St.	5	60	20	<i>The time in seconds for the aspirator operate on each pipe.</i>	Adm

Note:

1. Please goes to your local distributor for the manufacture level access code.
2. The default settings for pipe scan is disable and scan level is manual scan only. To set the VDOT-ASD-400 so it will scan automatically when alarm, both pipe scan and scan level should be set. For example, if you want VDOT-ASD-400 automatically perform pipe scan when there's an Alert condition, set the pipe scan to Enable and scan level to 1.

3. The scan time default setting is 20 seconds. Shorter scan time is possible if the pipe length is not long. In case the scan process is too time consuming, set the scan time to 15s is appropriate.

□ The Activation of Pipe Scan

The pipe scan can be activated automatically or manually. It can be activated automatically when the alarm reaches scan level setting. It can also be activated manually by the control button on the display. Press and hold the "SCAN" button will start the scan process in any time. It can also be activated by a GPI with which setting to 10 (scan). Hence, when this GPI is shorted the pipe scan is activated.

When the GPI is activated manually during an alarm condition, the pipe scan result will correspond to the alarm level. For example, when manually start the pipe scan during Action Alarm condition, after a successful scan it will generate Zone # Action Alarm condition (Zone # Alert and Action relays on the zone relay board will be activated). When the GPI is activated manually without an alarm condition, no result will be generated after scan.

Note:

- The scan result is shown on the display event log. User can switch the 6 digits Numerical Display to Aux looking for the event code.
- When the scan starts from an alarm condition, after pipe scan, beside the scan alarm level, the alarm levels lower than scan level will also be triggered. For example, if scan level is Fire 1, then the pipe scan will start when the detector has Fire 1 alarm. After scan, beside the Fire 1 alarm of the identified zone (pipe) is generated, Alert and Action alarms of the identified zone (pipe) will also be generated the same time.
- Scan process will be activated for scan level and the following alarm levels. For example, if the scan level setting is Fire 1, then there would be no scan for Alert and Action Alarms. The scan process will be activated when it has Fire 1 Alarm and Fire 2 Alarm. If the scan level setting is Alert then scan process will be activated when it has Alert, Action, Fire 1 and Fire 2 Alarms. i.e. When the detector has Alert Alarm, it will start a scan process, and then if the smoke is still high and trigger the Action Alarm, it will start another scan process... and so on. Cares should be taken if, for example, Fire 1 relay on the termination board is connected to Fire Alarm Panel. If this is the only means to inform the staff of the alarm conditions, then the time spent on pipe scan should be discussed to see if it's acceptable.
- If there's pipe not used and the pipe is disabled on the settings, this pipe will be ignored during pipe scan process.

Zone Relay Board

The VDOT-ASD-400 can be equipped with an optional Zone Relay Board to provide extra relay outputs for zone alarms and faults. There are 16 relays on a zone relay board. Relay 1~4 are the outputs for zone 1, relay 5~8 are the outputs for zone 2, relay 9~12 are the outputs for zone 3 and relay 13~16 are the outputs for zone 4.

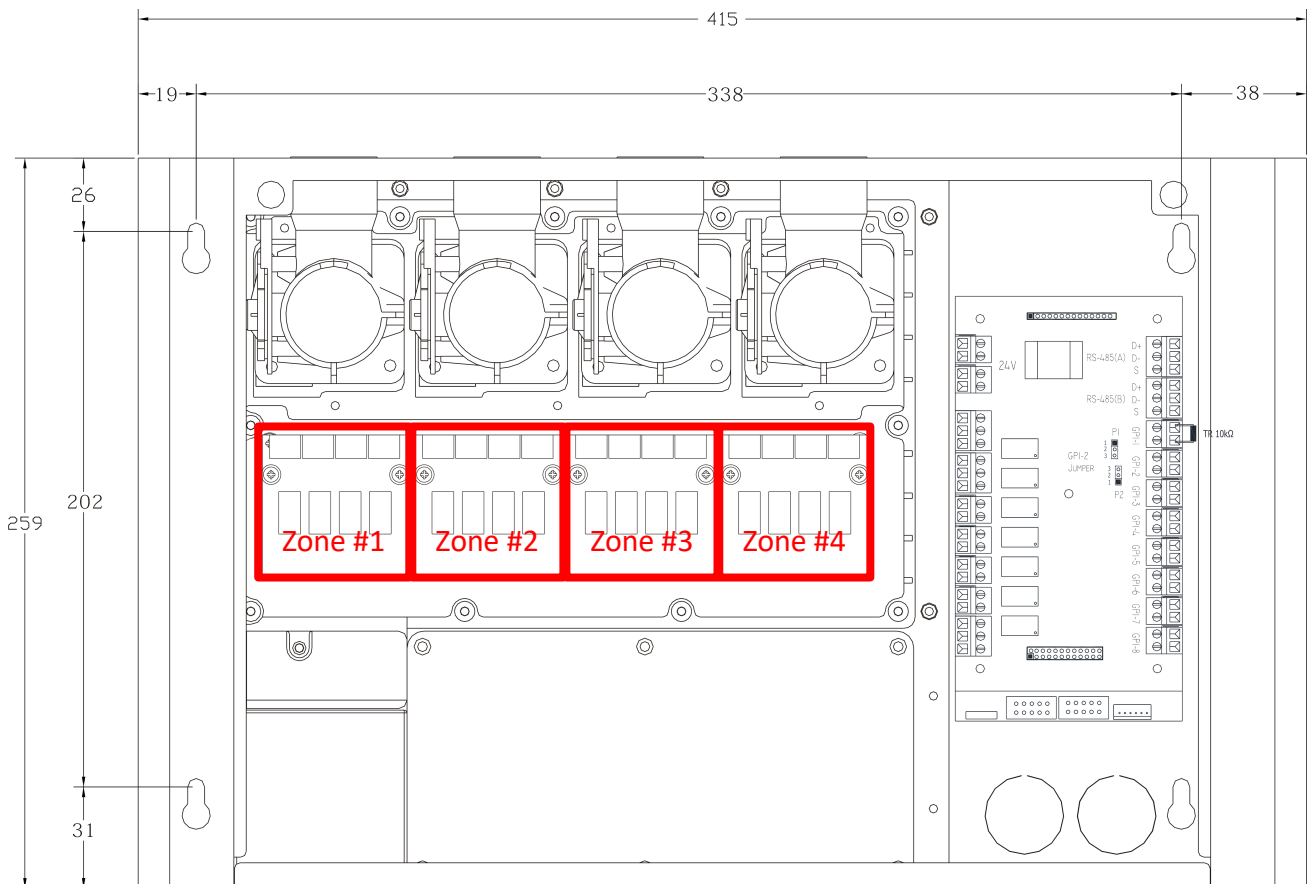

Zone Relays and their Zone ID on the Zone Relay Board (optional) in VDOT-ASD-400. The first relay in each zone is Normally Closed for its default setting is Fault. The 2nd/3rd/4th relays in each zone are Normally Open with default settings of Alert/Action/Fire 1 respectively.

The same as the device relays on the Detector Termination Board, all the relays on the Zone Relay Board are configurable. The default settings of the four relays on each zone are Fault/Alert/Action/Fire 1 respectively. Individual zone relay configuration can be changed by setting the relay number to the following value using the built-in display/programmer or from a remote computer via the RS485 network.

 **Important Note:**

Zone Relay Board must be enabled before it can function properly. The factory default setting of zone relay board is disabled. Please set the zone relay board in item 20 (optional modules) to ON to enable the module.

Zone Relays Function Settings

The following table is the Function Settings related to the use of zone relay board. The board must be enabled first in item 20 (optional module) so that item 11 settings can be seen and changed accordingly.

Item	Menu	Parameter	Lead No.	Min	Max	Dft	Description	Access Level
11	Zone Relay Configuration	Relay 1	01.	1	7	2	<i>Relay 1~4 is Zone 1 outputs Relay 5~8 is Zone 2 outputs Relay 9~12 is Zone 3 outputs Relay 13~16 is Zone 4 outputs</i> <i>The relay configuration is the same as device relays. 1: ISOLATE 2: FAULT 3: ALERT 4: ACTION 5: FIRE 1 6: FIRE 2 7: AUXILIARY</i> <i>Note: Relay 1/5/9/13 are Normally Closed the others are Normally Open.</i>	DST
		Relay 2	02.	2	2	3		
		Relay 3	03.	1	7	4		
		Relay 4	04.	1	7	5		
		Relay 5	05.	1	7	2		
		Relay 6	06.	1	7	3		
		Relay 7	07.	1	7	4		
		Relay 8	08.	1	7	5		
		Relay 9	09.	2	2	2		
		Relay 10	10.	1	7	3		
		Relay 11	11.	1	7	4		
		Relay 12	12.	1	7	5		
		Relay 13	13.	2	2	2		
		Relay 14	14.	1	7	3		
		Relay 15	15.	1	7	4		
		Relay 16	16.	1	7	5		
20	Optional Module	Zone Used	OP.	OFF	ON	ON	<i>Enable/Disable Zone</i>	DST
		Display Used	Od.	OFF	ON	ON	<i>Enable/Disable Display/Programmer</i>	
		Filter Used	OF.	OFF	ON	OFF	<i>Enable/Disable Filter</i>	
		Sensor Used	OS.	OFF	ON	OFF	<i>Enable/Disable optional Sensor Board</i>	
		Zone Relay Used	Or.	OFF	ON	OFF	<i>Enable/Disable optional Zone Relay Board</i>	

Please refers to the user's manual for the function settings using built-in display/programmer

Velocity Detection

Address: Detection House, 72-78 Morfa Road, Swansea SA1 2EN UK

Email: sales@Velocitydetection.com
<http://www.velocitydetection.com>